



**POOL**  
SYSTEM

# POOL LED LIGHT

» SMD LED.

» Premium Quality.

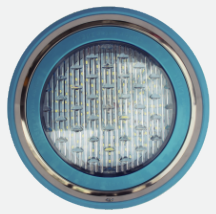

**POOL**  
SYSTEM

LGT-SD-A 3W



LGT-SD-A75-3W



LGT-SD-A100-3W



Product Benefits

- Multi-color are available
- Epistar or Bridgelux LEDs, creates amazing lighting performance.
- Easy to install and use.
- Low power consumption, no ultraviolet.

Product Features

- Widely used for decorative underwater area.
- High quality PMMA lens with good performance light.
- Safety working voltage (12V ac)
- Energy saving 80% to replace metal halide light.

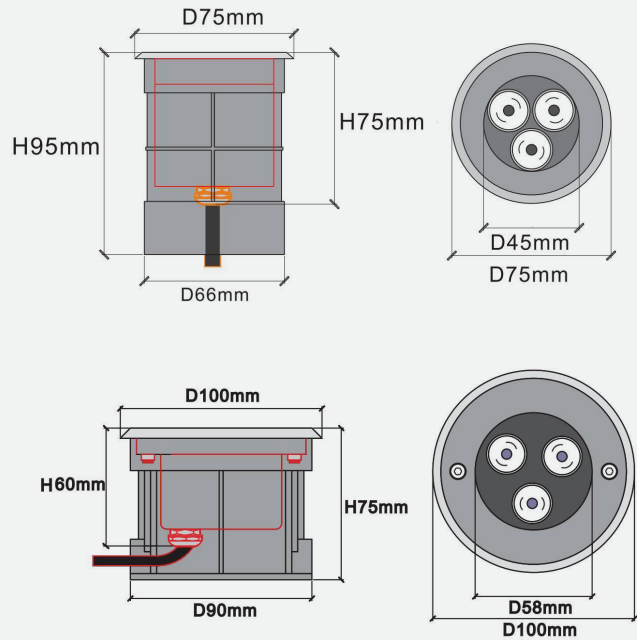

Technical Data

Item No.	Watts	Size (mm)	Cut hole	Temperature	LED Chips	Warranty
LGT-SD-A75	3W	D75*H95	D66*H95	W/WW/Y/R/G/B/RGB	Epistar/Brigellux/Cree	2 Years
LGT-SD-A100	3/9W	D100*H75	D90*H75	W/WW/Y/R/G/B/RGB	Epistar/Brigellux/Cree	2 Years

Beam Angle	Grade	Volt	Material	Packing	G.W(KG)
30/45/60	IP68	12V/24V	304 Stainless	20PCS/42*18*42CM	0.48
30/45/60	IP68	12V/24V	304 Stainless	40PCS/54.5*23*44.5CM	0.37

LGT-SD-A 6/9W



LGT-SD-A125-6W



LGT-SD-A150-9W



EPISTAR High-Power



Stainless Cover+screws



Stainless housing

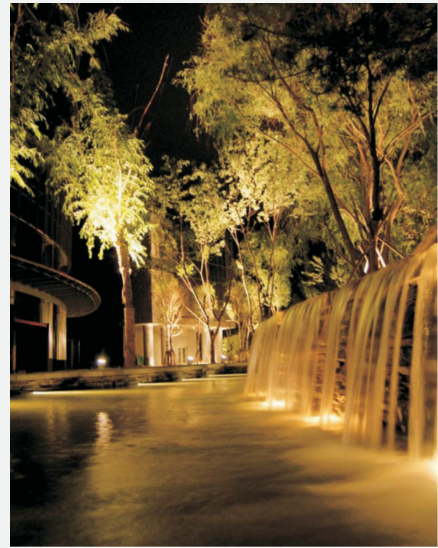

Product Benefits

- Multi-color are available
- Epistar or Bridgelux LEDs, creates amazing lighting performance.
- Easy to install and use.
- Low power consumption, no ultravoilt.

Product Features

- Widely used for decorative underwater area.
- High quality PMMA lens with good performance light.
- Safety working voltage (12V ac)
- Energy saving 80% to replace metal halide light.

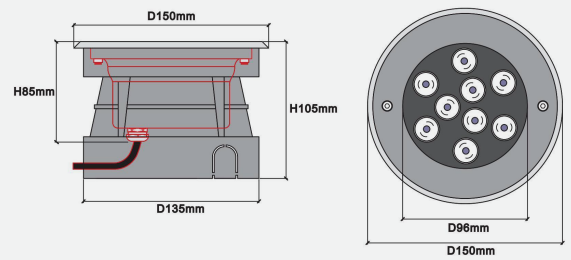
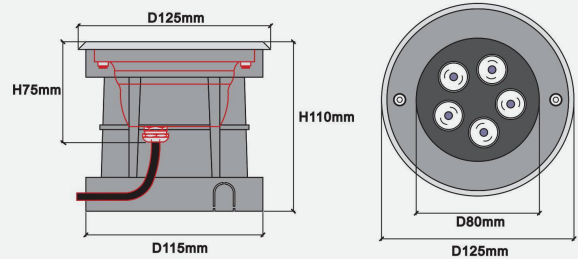

Technical Data

Item No.	Watts	Size (mm)	Cut hole	Temperature	LED Chips	Warranty
LGT-SD-A125	6/18W	D125*H110	D125*H110	W/WW/Y/R/G/B/RGB	Epistar/Bridgelux/Cree	2 Years
LGT-SD-A150	9/27W	D150*H105	D135*H105	W/WW/Y/R/G/B/RGB	Epistar/Bridgelux/Cree	2 Years

Beam Angle	Grade	Volt	Material	Packing	G.W(KG)
30/45/60	IP68	12V / 24V	304 Stainless	20PCS/70*28.5*25CM	0.68
30/45/60	IP68	12V / 24V	304 Stainless	12PCS/50*33.5*26CM	0.95

LGT-SD-A 12/18W



LGT-SD-A180-12W



LGT-SD-A210-18W



3-in 1 RGB controlled by RF remotor



Product Benefits

- Multi-color are available
- Epistar or Bridgelux LEDs, creates amazing lighting performance.
- Easy to install and use.
- Low power consumption, no ultraviolet.

Product Features

- Widely used for decorative underwater area.
- High quality PMMA lens with good performance light.
- Safety working voltage (12V ac)
- Energy saving 80% to replace metal halide light.

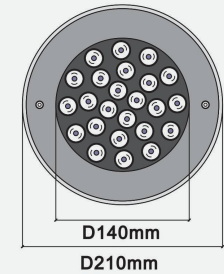
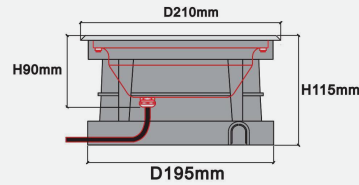
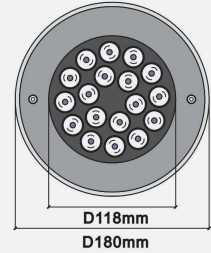
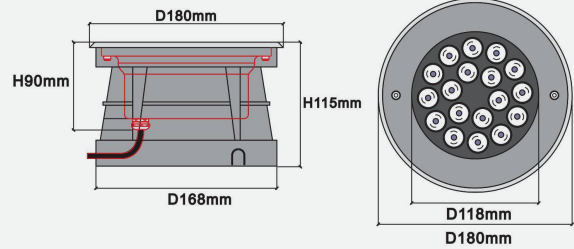

Technical Data

Item No.	Watts	Size (mm)	Cut hole	Temperature	LED Chips	Warranty
LGT-SD-A180	12/36W	D180*H115	D168*H115	W/WW/Y/R/G/B/RGB	Epistar/Bridgelux/Cree	2 Years
LGT-SD-A210	18/54W	D210*H115	D195*H115	W/WW/Y/R/G/B/RGB	Epistar/Bridgelux/Cree	2 Years

Beam Angle	Grade	Volt	Material	Packing	G.W(KG)
30/45/60	IP68	12V / 24V	304 Stainless	12PCS/27*38.5*28.5CM	1.35
30/45/60	IP68	12V / 24V	304 Stainless	8PCS/50*24*46CM	1.6