



Features & Advantages

- 100% factory tested according to international and Minder improved standard.
- Smart air release valve for manual & automatic air pressure release
- Designed to assemble with valve manifold
- In-fluent manifold distribution to prevent clogging
- Materials used are durable and suitable for all-weather performance
- 10 – 15 years life-time
- Available in standard 2.5bar and advance 4.0bar operating pressure model

Warranty

Fittings	1 year
Filter Tank	5 years

Minder B Series horizontal Commercial filters offer a much bigger filtration system for big commercial projects. B Series filters size range from 1050mm to 2500mm in diameter with optional accessories.

Operating Limits

Model	2.5bar	4.0bar
Maximum water temperature	40°C	40°C
Operating Pressure	2.5bar	4.0bar
Maximum Pressure	4.0bar	6.0Bar

Optional Components

- Nozzle collection system
- Internal sight glass
- Additional inline sight glass
- Sedi manhole
- Valve manifold (valve battery)
- Vinyl-ester internal coating

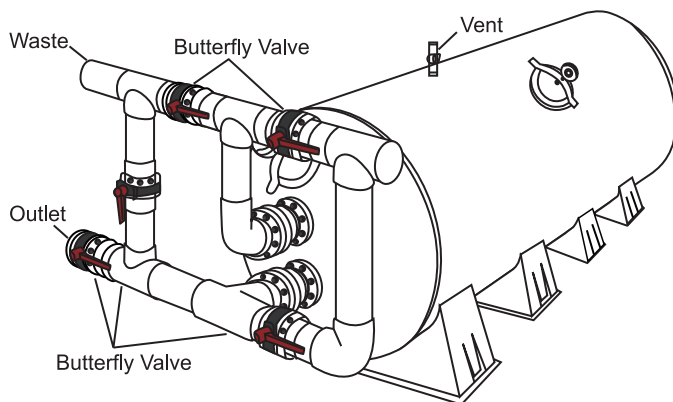

Optional configuration available by request

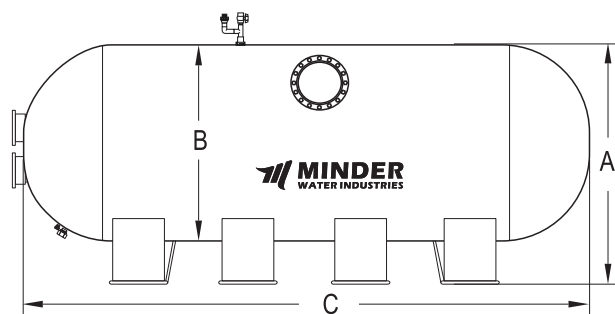
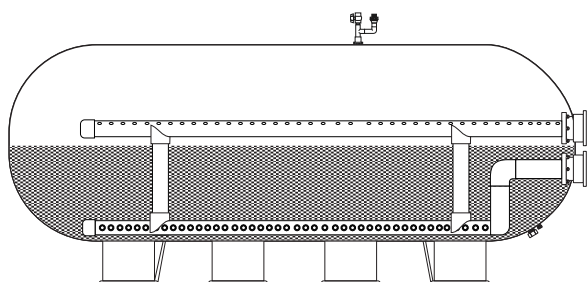

Technical Specification & Dimensions

Model	Code	Tank Ø	Height	Length	Flange Connection	Filtration Area	Designed Velocity	Maximum Flow Rate	Media Bed depth	Silica Sand (kg)	Gravel (kg)
		A	B	C							
		2.5bar	mm	mm	mm	m ²	m ³ /h/m ²	m ³ /h	mm	1-1.2mm	0.4-0.8mm
A: Tank diameter 1050mm											
B1050-1.9	70682	1050	1260	1,900	90	1.72	30	52	500	350	950
B1050-2.3	70683		1260	2,300	110	2.12	20	42		475	1,250
B1050-2.5	70684		1260	2,500	110	2.32	20	46		575	1,525
B1050-2.7	70685		1260	2,700	160	2.51	40	100		700	1,600
B1050-3.0	70686		1260	3,000	160	2.81	40	112		775	2,025
A: Tank diameter 1200mm											
B1200-2.5	70687	1200	1500	2,500	160	2.65	40	106	600	700	1,750
B1200-3.0	70688		1500	3,000	160	3.21	40	129		925	2,325
A: Tank diameter 1400mm											
B1400-2.5	70689	1400	1600	2,500	160	3.02	40	121	800	800	2,825
B1400-3.0	70690		1600	3,000	160	3.67	30	110		1,000	3,450
A: Tank diameter 1600mm											
B1600-2.5	70691	1600	1830	2,500	160	3.36	30	101	1000	850	3,875
B1600-3.0	70692		1830	3,000	160	4.1	30	123		1,050	4,750
A: Tank diameter 1800mm											
B1800-2.5	70693	1800	2050	2,500	160	3.74	30	112	1000	975	4,850
B1800-3.0	70694		2050	3,000	160	4.58	30	137		1,225	5,925
B1800-3.5	70695		2050	3,500	200	5.41	30	162		1,475	7,000
B1800-4.0	70696		2050	4,000	200	6.25	30	187		1,700	8,075
A: Tank diameter 2000mm											
B2000-2.5	70697	2000	2220	2,500	160	4.34	30	130	1200	1,050	6,575
B2000-3.0	70698		2220	3,000	160	5.3	30	159		1,300	8,025
B2000-3.5	70699		2220	3,500	200	6.25	30	187		1,550	9,475
B2000-4.0	70700		2220	4,000	200	7.21	30	216		1,800	10,925
B2000-4.5	70701		2220	4,500	200	8.16	20	163		2,075	12,375
A: Tank diameter 2350mm											
B2300-3.0	70702	2350	2560	3,000	160	5.94	20	119	1200	2,575	9,300
B2300-3.5	70703		2560	3,500	200	7.06	30	212		3,125	11,050
B2300-4.0	70704		2560	4,000	250	8.17	40	327		3,650	12,800
B2300-4.5	70705		2560	4,500	250	9.28	40	371		4,200	14,525
B2300-5.0	70706		2560	5,000	250	10.4	30	312		4,750	16,250
A: Tank diameter 2500mm											
B2500-3.5	70707	2500	2710	3,500	200	7.34	30	223	1300	3,175	11,675
B2500-4.0	70708		2710	4,000	250	8.62	40	345		3,725	13,500
B2500-4.5	70709		2710	4,500	250	9.8	30	294		4,300	15,350
B2500-5.0	70710		2710	5,000	250	10.98	30	329		4,850	17,200

Collection Systems

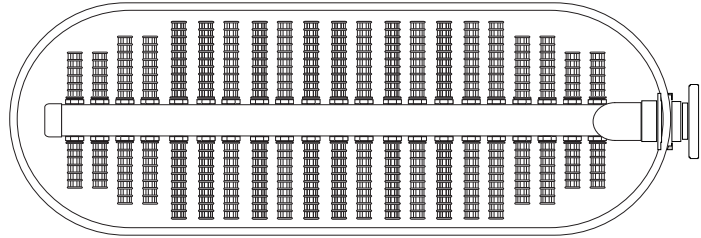
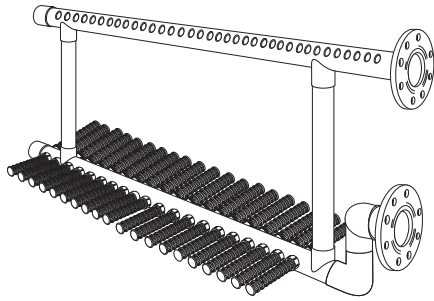

Standard Inclusions for F and B Series

All Minder commercial filters come with the following fittings. Please inform our representative if you prefer not to have these items installed.

Pressure Gauge Panel

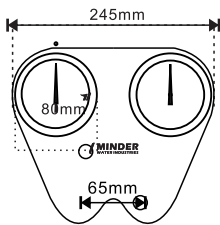

Every F or B series comes with a pressure gauge panel with dual extra large gauges. Gauges are oil-filled for long-lasting durability.

Re-order code: 30144

Water Drain



Easy draining of sand and water for F & B series

Re-order code: 70306

Smart Air Release Valve

Minder's unique feature "Smart Air Release Valve" can manually release the air inside the tank. Also, the one way valve is able to automatically release negative pressure during water drainage to minimize the impact to the filter tank.

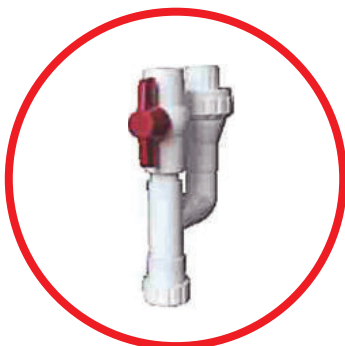

Re-order code: 90577

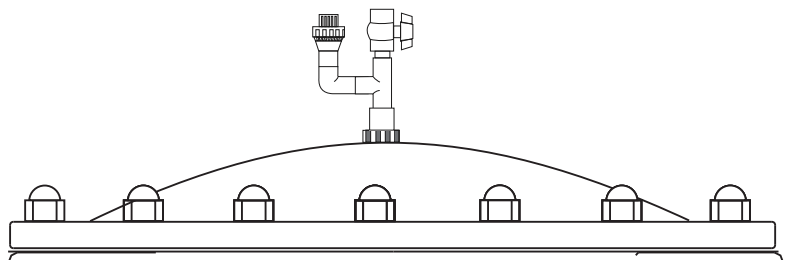

Internal Sight Glass

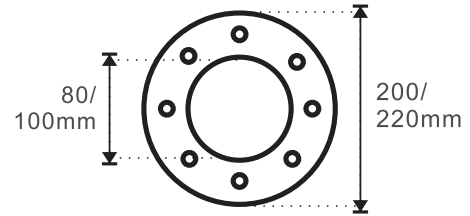
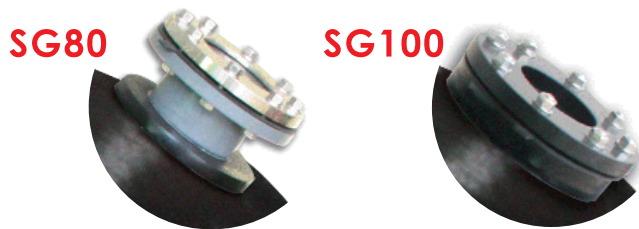

Model	Code	Inner Dia. (mm)	Outer Dia. (mm)
SG80	70713	80	200
SG100	70714	100	200

Operational internal sight glass for F or B series. Available in 2 sizes. Position above sand bed.

Inline Sight Glass (External Sight Glass)

Model	Code	Inner Dia. (mm)	Length (mm)
ILSG80	70715	80	150
ILSG100	70716	100	150
ILSG150	70717	150	150
ILSG200	70718	200	150

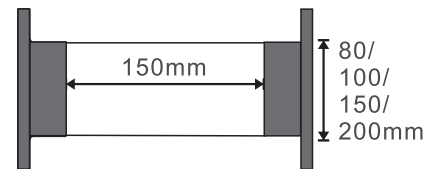

Optional inline sight glass for F or B series. Available in 4 sizes. Allows operators to effectively monitor water condition during backwashing.

Manhole

Model	Code	Inner Dia. (mm)	Outer Dia. (mm)
MH400	30234	400	520

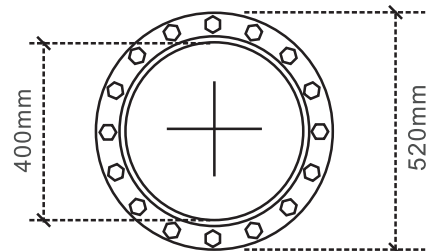

Optional manhole access for F or B series

Valve Manifold (Valve Battery)

Model	Code	Inner Dia. (mm)
MF80	70719	90
MF100	70720	110
MF150	70721	160
MF200	70722	210

